

Angle Head Dimensions

Reference Only • Detailed drawings available upon request

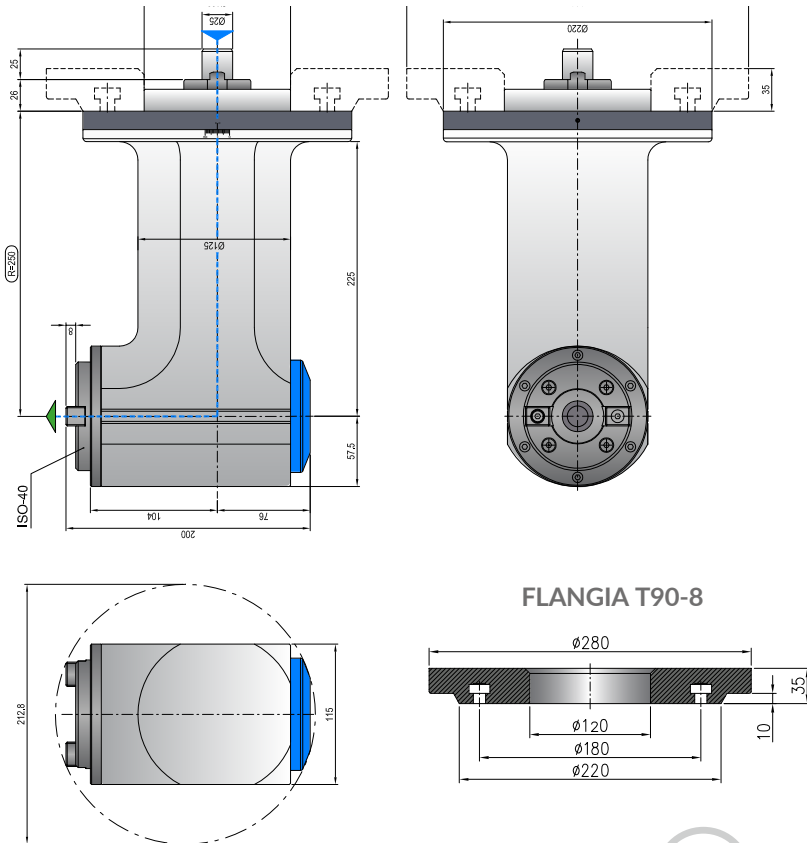

Direction of rotation opposite machine spindle. Dry rotation possible.

Max coolant pressure 100 bar, 1450 psi



Weight
72.6 lbs

Technical Features



Ratio
1.1



Collet
ISO/BT 40



Max. Axial Load
2.400 N



HS Torque
100 Nm



HS Tapping
Max. M20



HS RPM
6.000 min⁻¹



HP Torque
200 Nm



HP Tapping
Max. M27



HP RPM
4.500 min⁻¹

- Also available without coolant. Maximum speed 4,000 min⁻¹

INPUT TAPER

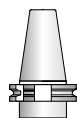

DIN-69871

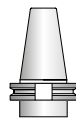

CAT

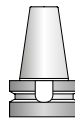

MAS-BT

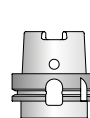

HSK

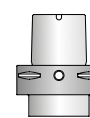

CAPTO

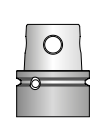

KM

PLUS

- Dry running also possible (4,000 min⁻¹)
- Gears with 4 - key drive
- Increased torque thanks to bigger gears